

# Electric pump

## EL300A/B

PUMP SPECIFICATIONS	Mod. A	Mod. B
Capacity [m <sup>3</sup> /h]	900	1200
Head [m]	33	25
Impeller diameter [mm]/type	760/2 blades closed	
Flanged bore size [DN.../PN...]	DN250/PN10	DN300/PN10
Cross section diameter [mm]	120	
Weight (without cable) [kg]	6000	6050

ELECTRIC MOTOR	
Power [kW-HP]	240-325
Voltage [V]/Current [A]	400/433
Phases/Poles/Frequency [Hz]	3/8/50
Speed [RPM]	740
Insulation class	H
Power cable 20m (IEC 60245- 4)	H07RN-F 4G95

MATERIALS	
Casing	Spheroidal cast iron EN-GJS-500-7 (EN 1563)
Motor housing	Cast iron EN-GJL-250 (EN 1561)
Wear parts	High chrome EN-GJN-HV600 (XCr18) (EN 12513)
Main shaft	High tensile steel 39NiCrMo3 (AISI 9840)

SEALS / LUBRICANT	
Motor side seals	1 mechanical seal (silicon carbide in oil bath)
Impeller side seals	1 mechanical seal (silicon carbide in oil bath) + 2 lip seal (1 BUNA + 1 TPU)
Oil type	ISO 320

DIMENSIONS [mm]							
H	W	D	F	H1	A	B	C
3250	1600	1357	1015	2600	652	750	453

### PERFORMANCE CURVES

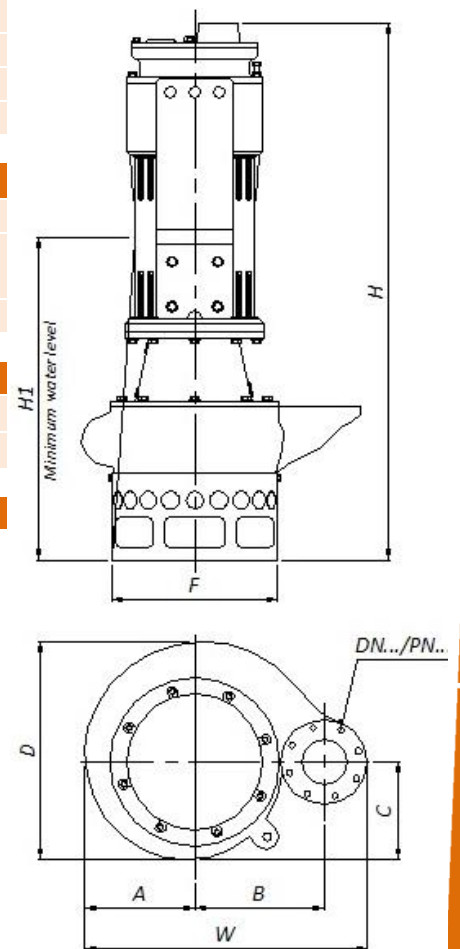
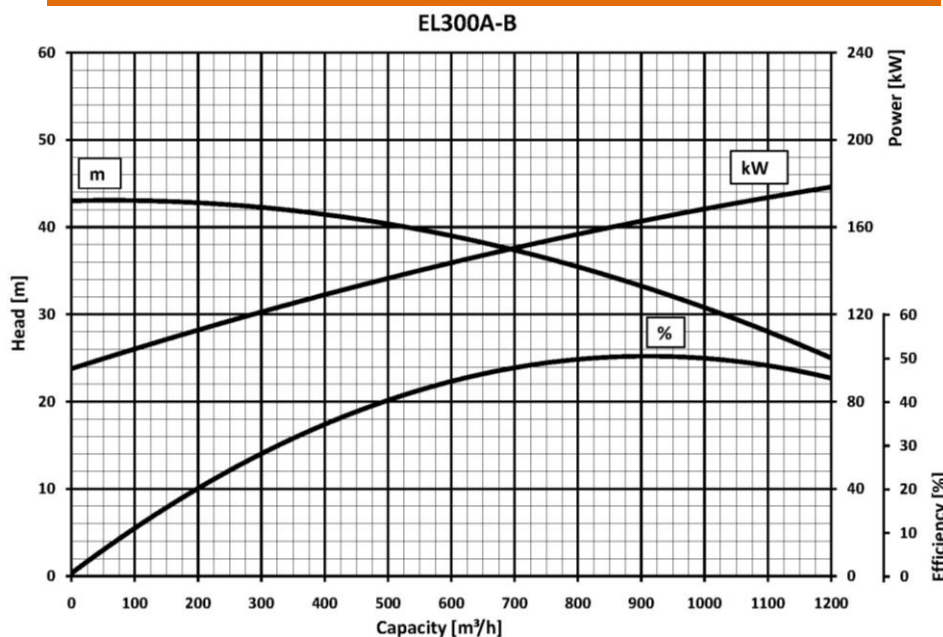

# EL300A-B

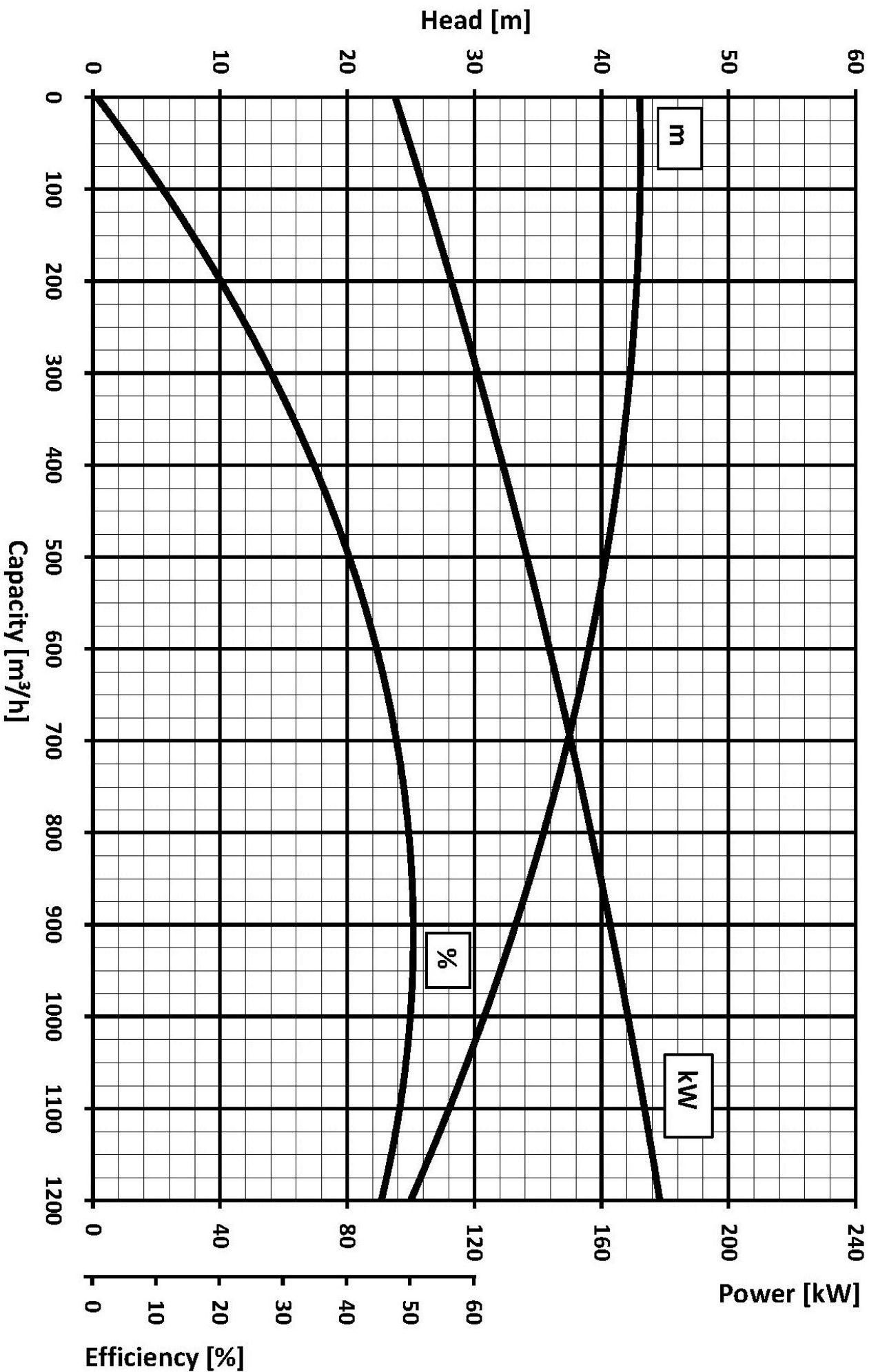

We reserve the right to make changes without notice