

Electric pump

EL35HC

PUMP SPECIFICATIONS

Capacity [m ³ /h - (USGPM)]	210 - (925)
Head [m - (ft)]	15 - (49)
Impeller diameter [mm - (in)]/type	350 - (14)/2 blades closed
Flanged bore size [DN.../PN... - (in)]	DN150/PN10 - (6)
Cross section diameter [mm - (in)]	60 - (2.4)
Weight (without cable) [kg - (lbs)]	750 - (1650)

ELECTRIC MOTOR

Power [kW-HP]	26-35
Voltage [V]/Current [A]	460/45.7
Phases/Poles/Frequency [Hz]	3/6/50
Speed [RPM]	1180
Insulation class	H
Power cable 20m (IEC 60245- 4)	H07RN-F 4G16

MATERIALS

Casing	Spheroidal cast iron EN-GJS-500-7 (EN 1563)
Motor housing	Cast iron EN-GJL-250 (EN 1561)
Wear parts	High chrome EN-GJN-HV600 (XCr18) (EN 12513)
Main shaft	High tensile steel 39NiCrMo3 (AISI 9840)

SEALS / LUBRICANT

Motor side seals	2 lip seals (BUNA)
Impeller side seals	3 lip seals (BUNA) + 1 V-RING (TPU)
Oil type	ISO 320

DIMENSIONS [mm - (in)]

H	W	D	F	H1	A	B	C
1480	905	700	545	990	350	410	310
(59.2)	(36.2)	(28)	(21.8)	(39.6)	(14)	(16.4)	(12.4)

PERFORMANCE CURVES

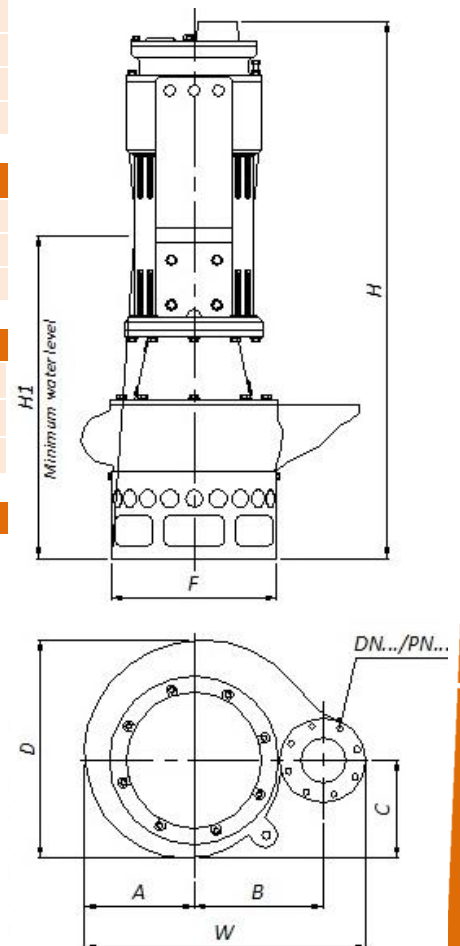
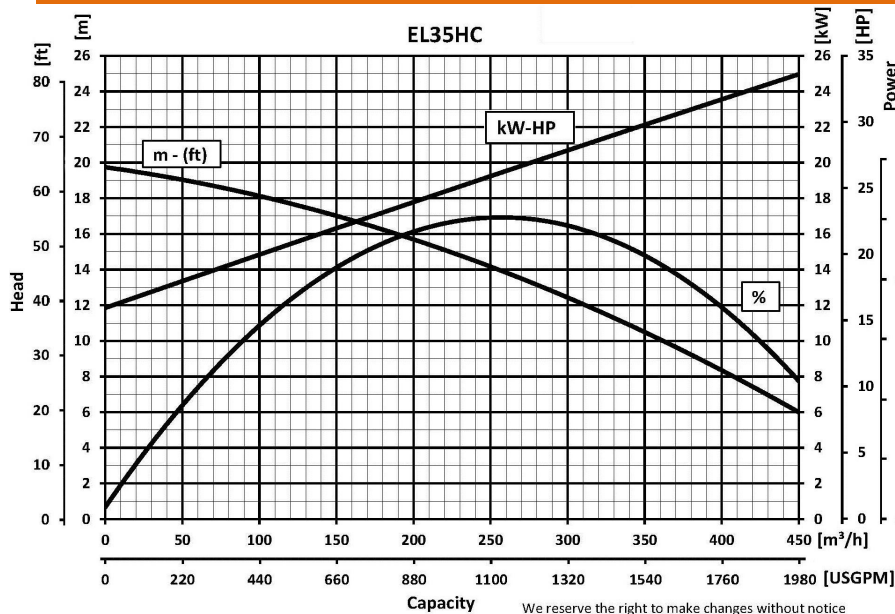

EL35HC

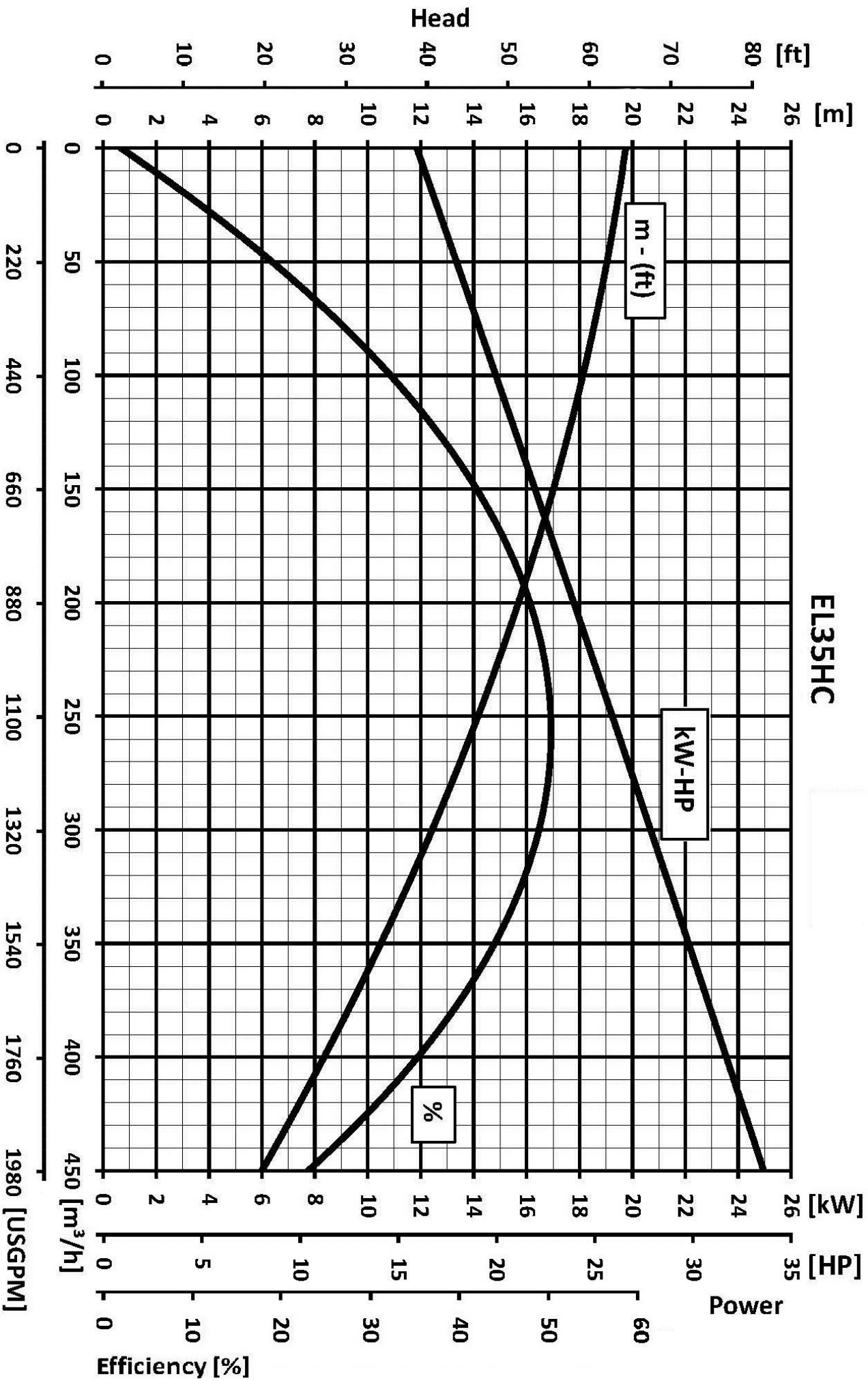

Capacity

We reserve the right to make changes without notice